

IMPACT 4530

ADDITIVE MACHINE TOOL





APPLICATIONS

IMPACT 4530 IN USE

With many years of experience in additive manufacturing, IRPD is your partner for the topology- and function-optimized components in the machine tool, aerospace, tooling, automation, energy, automotive, and medical industries – anywhere, in fact, where function or component weight optimization is necessary.

IMPACT 4530 (LPBF – Laser Powder Bed Fusion), the modular designed and scalable additive machine “Made in Switzerland” for industrial AM production of metals, fulfils the goal of Industry 5.0. IMPACT 4530 supports cooperation between humans and smart machines through intuitive control and Big Data, always providing the customer with the highest productivity and flexibility in the required parts quality. Thanks to the closed inert process chain the printing process is sustainable and resource saving.

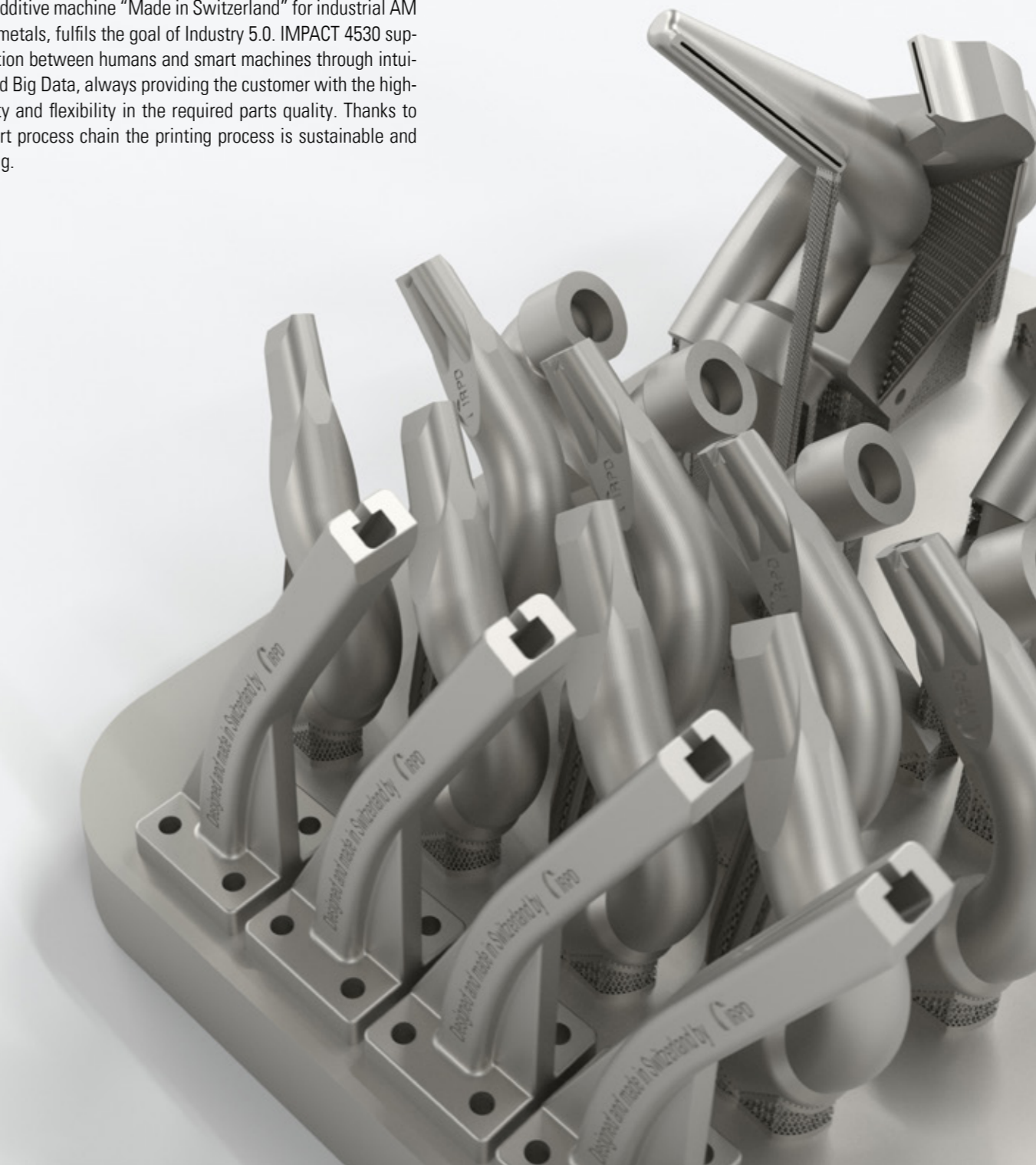

IMPACT 4530

PERFORMANCE DATA

- 2/4 fiber lasers with 1,000 W each
- 2/4 scanners with 3D optics
- Laser beam diameter 90–250 µm (0.0035–0.01")
- Build dimensions 450 × 300 × 400 mm (17.7" × 11.8" × 16")
- Build volume approx. 54 liters (14.3 US gal.)

HARDWARE

- Thermostabilized machine core with a gray cast iron machine base
- Supply unit as a welded frame construction, fully accessible from 3 sides
- Stable laser beam positioning with decoupling of the optical bench from the process chamber
- Operating side with C.O.R.E. panel, completely powder-free workspace
- Loading area fully separated from operating side
- Manual loading/unloading process of the gas-tight and inert build and powder supply containers, with automated internal container handling within the machine
- Hardware packages for laser-, scanner- and camera calibration, vacuum technology, pyrometry, and build plate heating
- Machine accessible from three sides for maintenance
- Simple and fast cleaning of the process chamber, quick machine changeover for different materials

SOFTWARE

- C.O.R.E. operating system
- IRPD build processor for additive manufacturing, incl. load balancing
- IRPD process database for various customer-oriented production strategies
- Process monitoring on/off-axis
- Software packages for calibration, self-setup routine, process monitoring, and process control

“IMPACT 4530 –
the additive machine tool
for industrial additive manufacturing
of metal parts”

YOUR BENEFIT

- Additive machine tool “Made in Switzerland”
- Worldwide with the UNITED GRINDING Group, always close to our customers, with approx. 50,000 installed machine tools
- Highly productive with up to four 1,000W lasers thanks to multi-beam strategy, full-field optics, advanced functionality, and minimal non-productive time (job to job) due to fast automatic container and material changeover
- Industry 5.0 standard thanks to an inert and sealed off process, a benchmark in terms of ergonomics, with a control that is intuitive and in line with customer expectations
- Maximum flexibility and material changeover in less than 120 minutes
- Process monitoring through intelligent collaboration between human and machine using HMI, UX, Digital Solutions, and C.O.R.E. from the UNITED GRINDING Group
- Scalable modular build concept Powder-2Part® in additive manufacturing
- Quality on the workpiece thanks to homogeneous energy input with optimized shield gas flow, stable and constant laser beam position, as well as a thermo-stabilized machine core
- Data acquisition through a comprehensive process and machine sensor technology as a basis for future controlled manufacturing processes (machine learning) and predictive maintenance

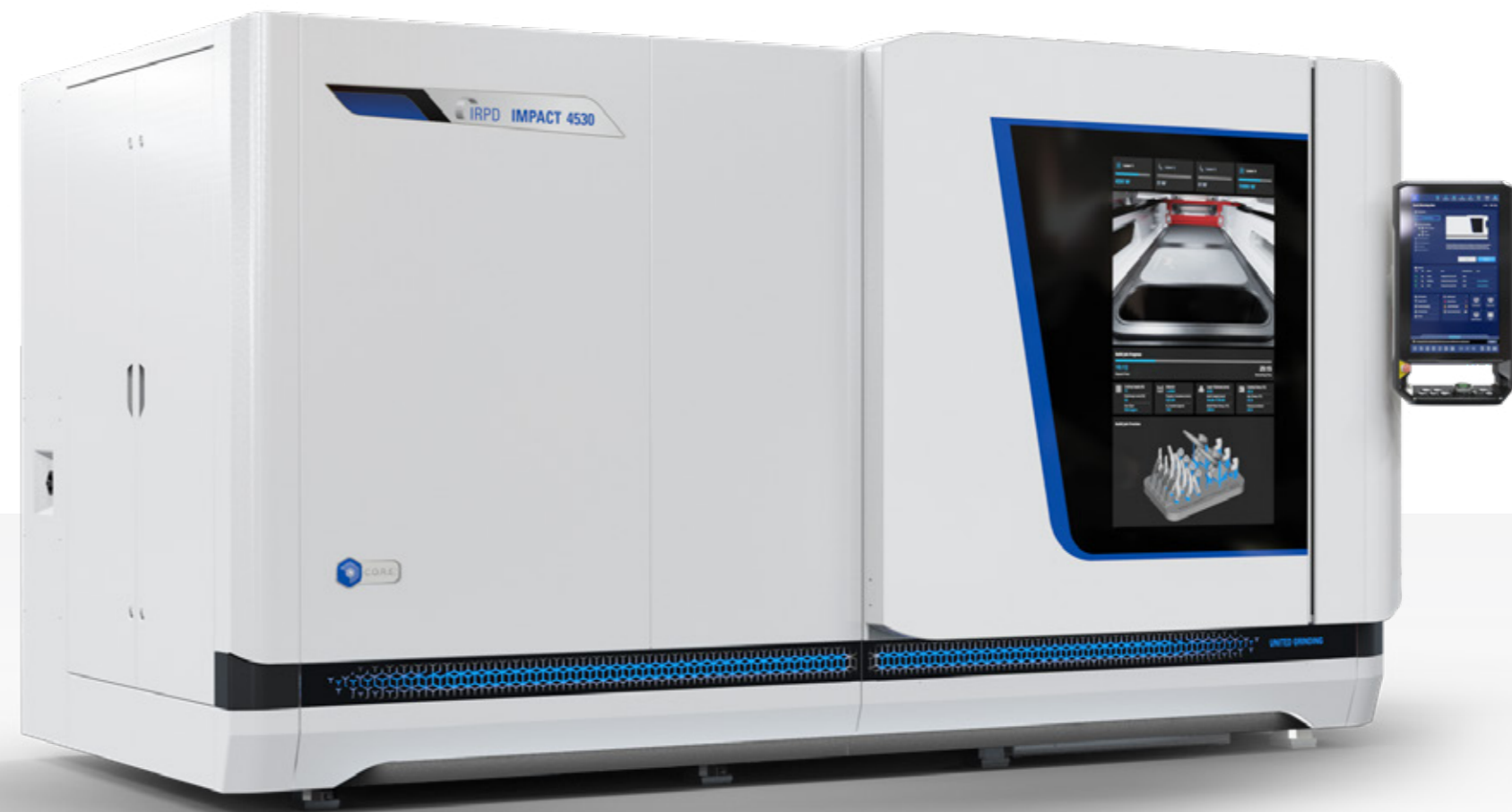



HUMAN – MACHINE

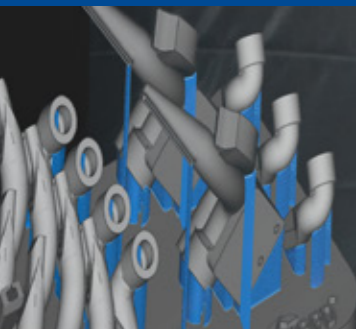

INNOVATIVE OPERATING AND MONITORING

Intuitive

The IMPACT 4530 supports the machine operator with an intuitive operating concept. Build jobs are prepared offline at a CAD-CAM workstation and transmitted to the machine as a fully defined print job.

HMI

The job file is downloaded onto the C.O.R.E. panel using the touchscreen, and the mainly autonomous machine preparation is initiated. The IMPACT 4530 is ready for production in just a few minutes. Programming or configuring on the machine is a thing of the past; all process-specific parameters are predefined in the job file.

All in one

The camera installed in the process chamber transmits a virtual view of the process directly to the 54" screen in the front door. Together with values measured on the machine, job file target data, and process monitoring sensor data, a detailed overview of the process status is thus guaranteed at any time, also online in the internal network.

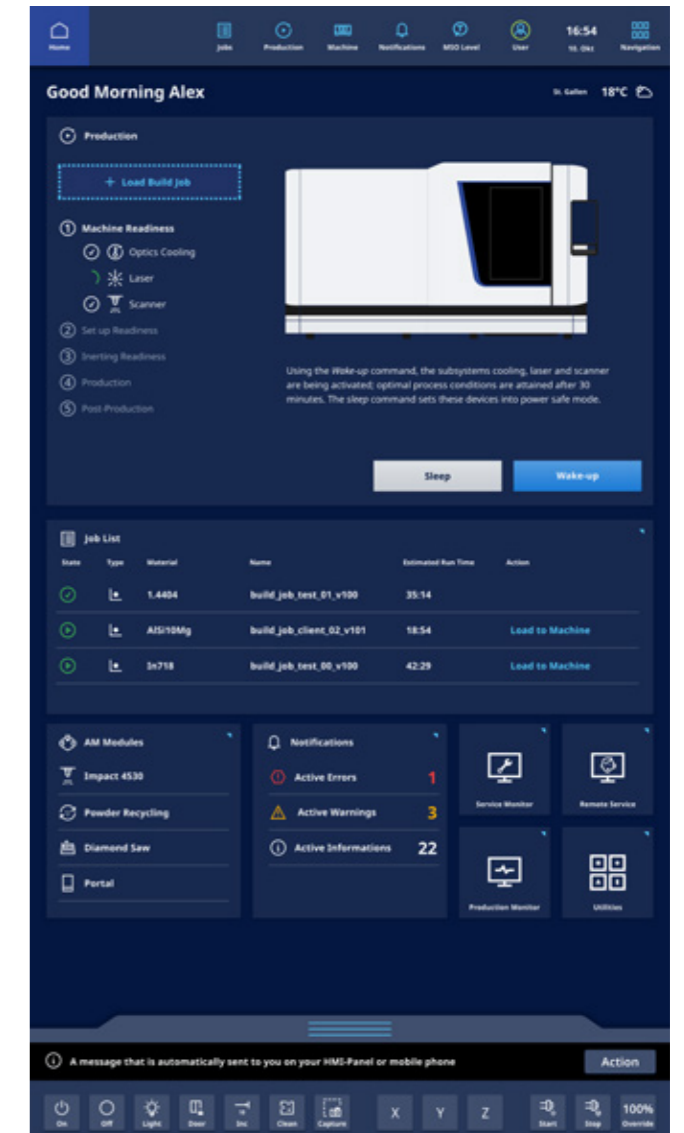
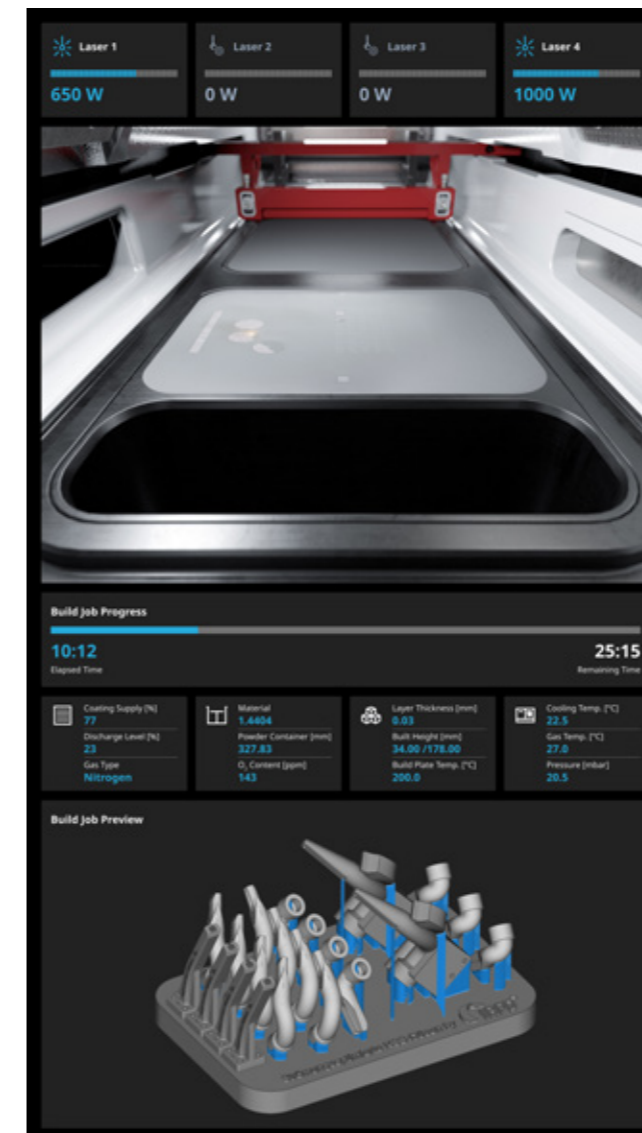

C.O.R.E. – CUSTOMER ORIENTED REVOLUTION

C.O.R.E. helps us make your production fit for the digital future.

It's based on a new operating system, C.O.R.E. OS that equips the machine with intelligence.

Thanks to the uniform C.O.R.E. software architecture, exchanging data between UNITED GRINDING machines is easy. The integrated umati API can be used to communicate with third-party systems as well. It also offers access to UNITED GRINDING Digital Solutions™ products directly on the machine. C.O.R.E. not only establishes the technical foundation for this and other IoT and data applications, it also forms the basis of revolutionary yet uniform operation.

What does this mean for you?

- The user-friendly, intuitive, and uniform operation makes work easier for machine setters, machine operators, and maintenance staff
- Standardized data collection and intelligent processing of data create transparency and supports process optimization
- The uncomplicated and consistent use of modern digital software solutions is guaranteed – directly on the machine
- The technical platform for the use of modern IoT and data applications has been established

C.O.R.E. ELEMENTS

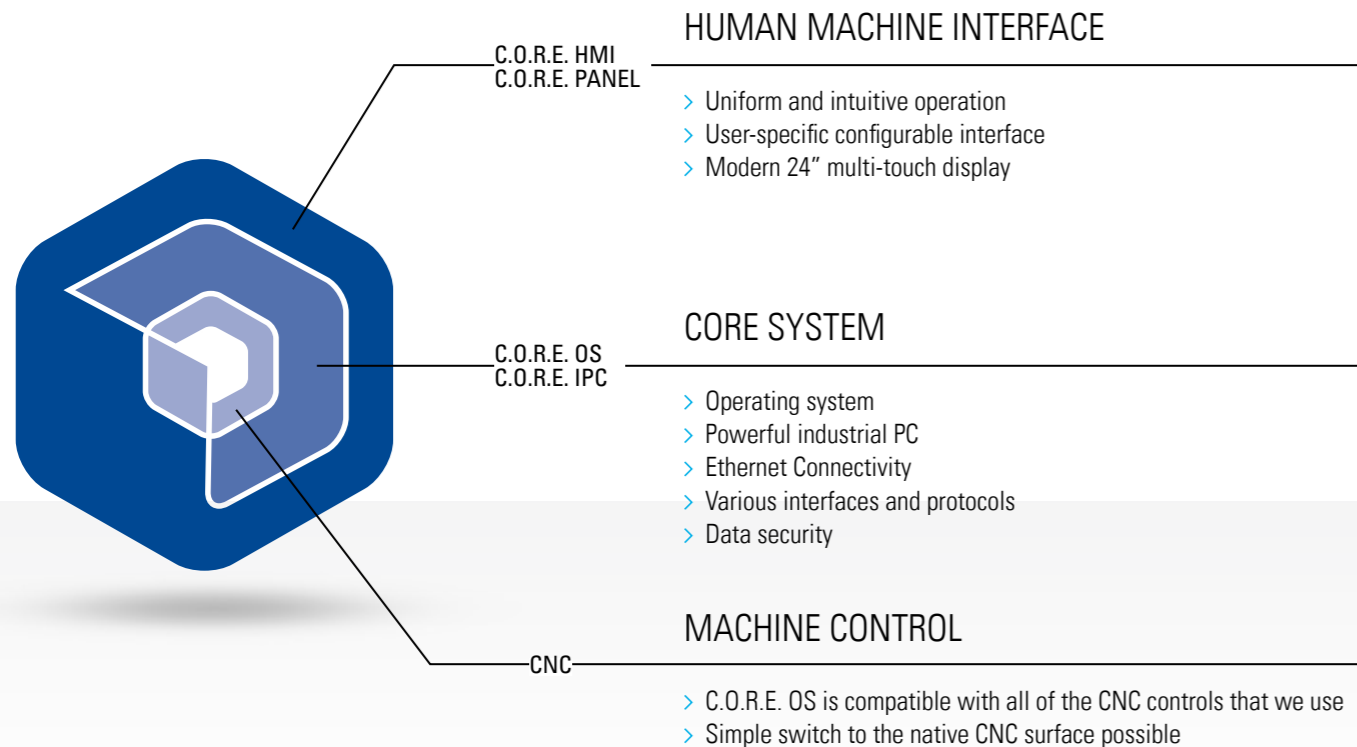

C.O.R.E. PANEL – THE FUTURE OF OPERATION

Intuitive

Thanks to intuitive design with self-explanatory icons, navigation through the machine menu and process steps is quick and easy. Instead of buttons, the user is presented with a modern and clearly arranged multi-touch display.

User-friendly

Each user configures their own user interface individually. This is called up automatically with the RFID chip after logging in. When the user leaves the machine, the panel switches to "Dark Factory Mode". Production progress and the machine state are also clearly visible from a

distance. And thanks to the ergonomic design, the panel can be tilted and individually adjusted easily.

Efficient

The uniform and intuitive operating philosophy reduces training time. The configurable and role-specific interface helps prevent errors and increases the efficiency and quality of programming. Information can be exchanged quickly and in real-time via the front camera and Bluetooth headset. UNITED GRINDING Digital Solutions™ products can be used directly on the panel.

INDUSTRIAL MULTI-TOUCH DISPLAY

INTEGRATED FRONT CAMERA

SELF-EXPLANATORY ICONS

USER-CONFIGURABLE DISPLAY

STANDARDIZED FUNCTION KEYS

ERGONOMIC OVERRIDE SWITCH



Technical Specifications

- 24" Full HD multi-touch display
- 16-position rotary override switch
- Electronic key switch (RFID)
- Integrated front camera
- Bluetooth V4.0 for headset connection
- 2x USB 3.0 ports
- Adjustable tilt



MACHINE TOOL STANDARD

PROCESS UNIT

Metallic AM parts manufactured by selectively melting metal powder applying the LPBF (Laser Powder Bed Fusion) process can be realized on the IMPACT 4530 at any time with high productivity and in the required quality.

The IMPACT 4530, essentially consists of two machine sections: the thermo-stabilized machine core as a cast iron machine base and the supply unit as a welded frame construction. The concept of the IMPACT 4530 enables powder contamination-free industrial additive manufacturing of metallic parts by having separate operator and loading areas and by performing powder and part management using sealed containers.

The machine core, the central part of the additive machine tool, designed to be rigid and without compromise, is based on our many years of experience of over 150,000 delivered machine tools. It forms the basis of a reproducible and stable manufacturing process. The design of the optical components and the inert gas flow guarantees consistent conditions across the entire build area and thus the production of high-quality components with high productivity.

The idea to separate operating and loading areas established in the system concept, together with the container changing system gives an opportunity to integrate IMPACT 4530 into a highly automated system network.

The system technology fulfils the highest quality demands through a completely closed and inert powder circuit, the dedicated build plate and part handling.

- Thermo-stabilized machine core
- Machine operation without any contact with metal powder
- Accessibility from three sides for container handling and maintenance

VACUUM-CAPABLE PROCESS CHAMBER

In addition to the structural design components, the process chamber in which the manufacturing process takes place is also a cast iron component. The very rigid cast structure, together with the build and powder container, results in a hermetically sealed process chamber, which can be vacuum evacuated before inerting, to reduce non-productive time or to increase the quality of the process atmosphere. At the same time, the process chamber, which is additionally thermostabilized by a sophisticated internal inert gas guidance system, forms a solid basis for the optic bench.

Cleaning work, which is typically required after a build-job or a change of material, is easy due to the optimized interior chamber geometry (no undercuts and no corners) and the smooth chamber coating.

- High-quality process atmosphere
- Minimal nonproductive times between build-jobs
- Easy cleaning of the process chamber interior

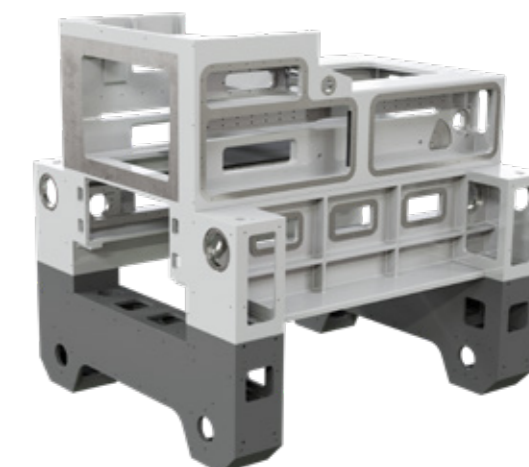



BUILD AND POWDER SUPPLY CONTAINER

Short nonproductive times between build-job 1 and build-job 2 can be realized via an automated container changing system. The metallic powder from which the components are printed, as well as the parts built up on a build plate, are fed to the system with two containers (build and powder supply container), and removed again after a completed build job.

The handling of the powder and AM parts in the gas-tight containers enables fast loading and unloading of the system. In the event of a material change, the cleaning of the system is minimal. The concept of the machine and the various machine options actively support the cleaning process, the nonproductive times are reduced, and the productivity increased.

Between the different processes (LPBF, depowdering and the separation of parts), the containers with their lids protect the powder from oxidation and the operating personnel from contamination with the metal powder.

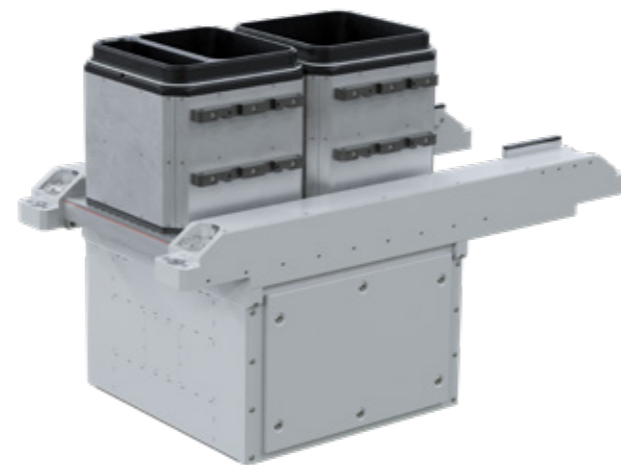

- No contamination of the metal powder
- Minimal nonproductive time in the printing process; job to job in 15 minutes
- Maximum flexibility during material changes

HOMOGENEOUS POWDER APPLICATION

Homogeneous powder application is a fundamental prerequisite for a stable production process. The coating process in the IMPACT 4530 can be conducted with either of two coating systems, a single-lip coater or a multifunctional coater system.

The latter allows various preparatory and accompanying functions to be performed autonomously, e.g., handling the container lids, a part of the self-setting routines, and the cleaning process.

The manual operating effort is thus reduced to a minimum. At the same time, the system creates further advantages, such as the autonomous replacement of a damaged or a poor-quality coater lip during the build job.

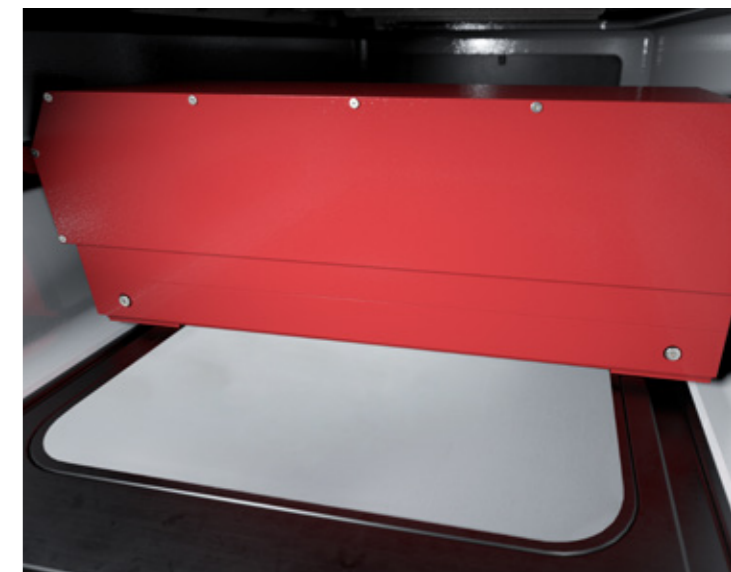

- Increased system productivity
- Automatic coater lip change
- High system autonomy

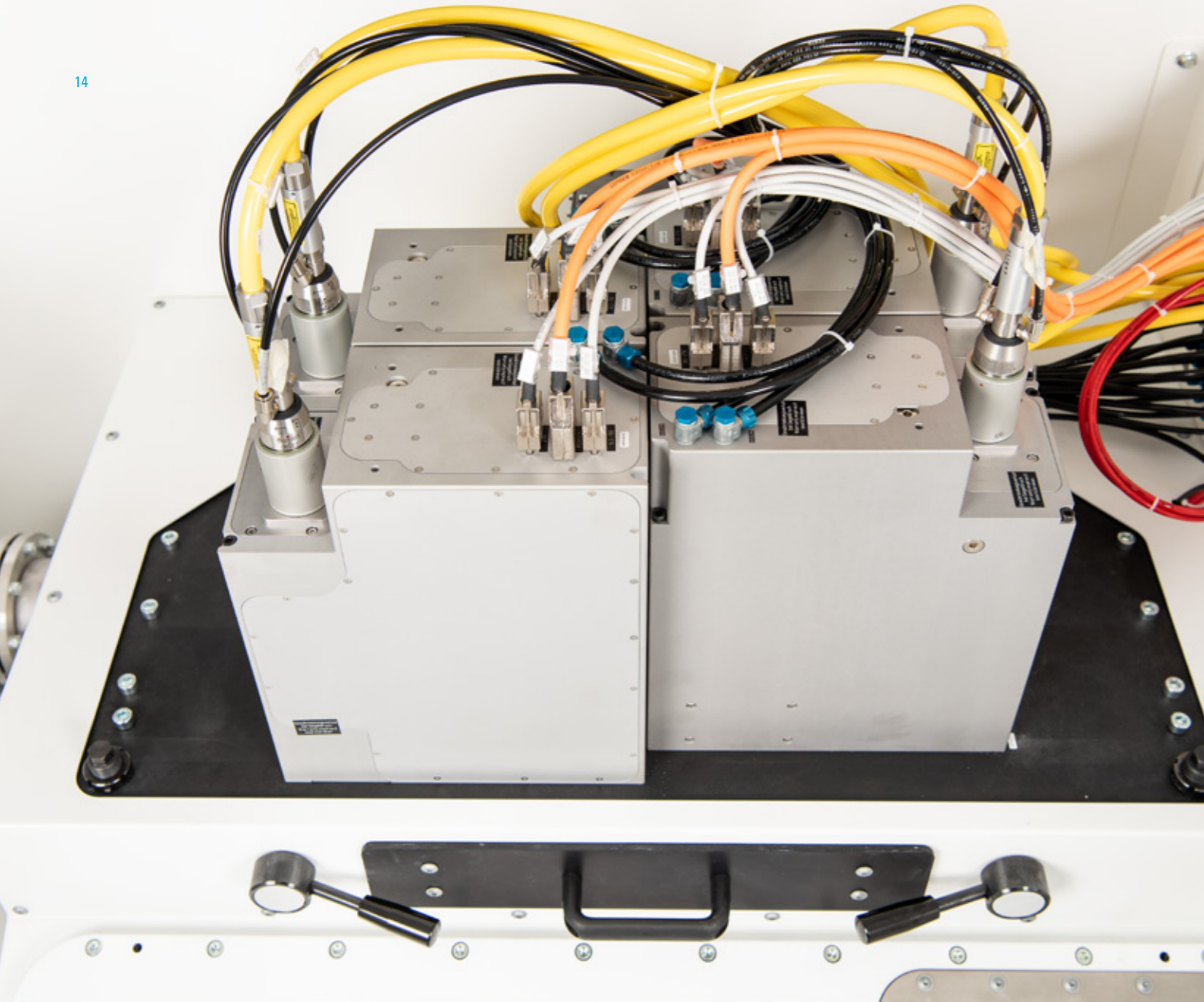

OPTICAL BENCH

Depending on the machine configuration, two or four laser deflection units with sensors are installed on the optic bench for comprehensive process monitoring and data acquisition. The fiber lasers, each with 1,000 W and optimally synchronized for a powerful multi-beam strategy, ensure maximum productivity of the LPBF process.

Requirements for the component (material density, surface quality) and the build job (productivity) are optimized on the IMPACT 4530 using a variable beam diameter in the printing process.

In addition to the scanner technology, various sensor technologies are installed to detect process emissions from the immediate melt pool area and the freshly applied powder layer. Various highly automated stages of laser and build field calibration consistently allow optimal adjustment of the optical components. Even during long build jobs, the highly accurate alignment of the lasers relative to each other can thus be ensured, and this with consistent quality with each deflection unit over the entire build plate area.

- Highly integrated process monitoring with expansion option for closed-loop control
- Machine-integrated calibration routines for all lasers and scanners
- Four lasers optimally synchronized through prior work allocation

INERT GAS AND TEMPERATURE CONTROL

Since LPBF (Laser Powder Bed Fusion) belongs to the group of micro welding processes, a good inert gas atmosphere is crucial for the microstructure of the components. The flow of inert gas extracts fume and spatter; this enables a uniform energy input over the entire working area.

The IMPACT 4530 was essentially designed to ensure an ideal and homogeneous flow of inert gas. The process chamber and gas-conducting components were optimally shaped using extended flow simulations, and the inert gas preparation is based on precise measurements of pressure, flow, oxygen and moisture content, and gas temperature.

The specific temperature control of the inert gas significantly stabilizes the thermal behavior of the overall machine. Furthermore, the IMPACT 4530 has dedicated water cooling at neuralgic areas to prevent drift of electronical components and the thermal expansion in the mechanics and optics.

- Precise inert gas flow management with data from up to ten sensors
- Homogeneous inert gas conditions over the entire build area thanks to CFD-based design
- Reduction of soot deposits through targeted inert gas injection
- Separate water circuits for temperature control of electronics, optics, and mechanics

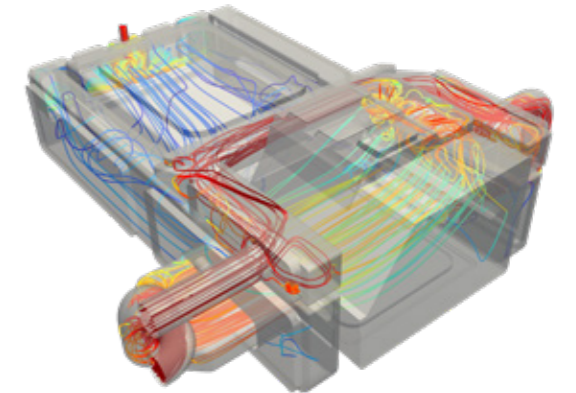

SUPPLY UNIT

The supply unit of the IMPACT 4530 provides centralized space for all aggregates that support the industrial, stable manufacturing process such as: inert gas filtration, laser units, vacuum pump, high performance internal thermostabilizing, and control cabinet.

The preparation of the inert gas, which is essential for the process, includes metering, circulation, cooling, and filtration. The central element is the wear-free, calcium carbonate-charged, solid-state filter, which enables the best filtration results under constant process conditions. The discharge is provided safely and inertly in easily manageable sheet metal containers.

Access to all essential peripherals is ensured by a unique maintenance access channel between the process unit and supply unit.

- Constant process conditions
- Good accessibility
- Easy and risk-free filter handling



SCALABLE – FROM STAND-ALONE TO FULLY AUTOMATED

From a stand-alone solution to fully automated production with integration of downstream processes, the IMPACT system concept meets the highest demands in terms of flexibility and degree of automation.

Depending on the application and customer requirements, the IMPACT 4530 can be used as a stand-alone machine as well as with other IMPACT 4530's and machines to perform downstream processes (IRPD PM1 & PM2 de-powdering, IRPD CM1 print part separation, post-processing, measuring).

- Risk-free operation of the system on the operating side
- Ideal accessibility to the equipment from three sides during cleaning and maintenance
- Flexibly scalable from stand-alone to a fully automatic integrated system

Thanks to the separate operating and loading areas, which is also implemented accordingly in the machines for the downstream processes, the IMPACT 4530 can be optimally combined with an automation cell (IRPD HM2).

In a stand-alone operation, a multifunctional electric stacker truck with a dedicated special fork (IRPD HM1) is used for moving and turning the containers and the build plates. The operator can use this device to supply the IMPACT 4530 and the machines for the downstream processes with the containers and the build plates ergonomically.

When using an automation cell (IRPD HM2), several IMPACT 4530's or machines for the downstream processes can be combined, and depending on the application and requirements, all tasks (container handling, build platform handling, component handling) handled by the automation cell.

In this case, the tasks of the system operator focus on monitoring, maintaining, and cleaning the equipment.

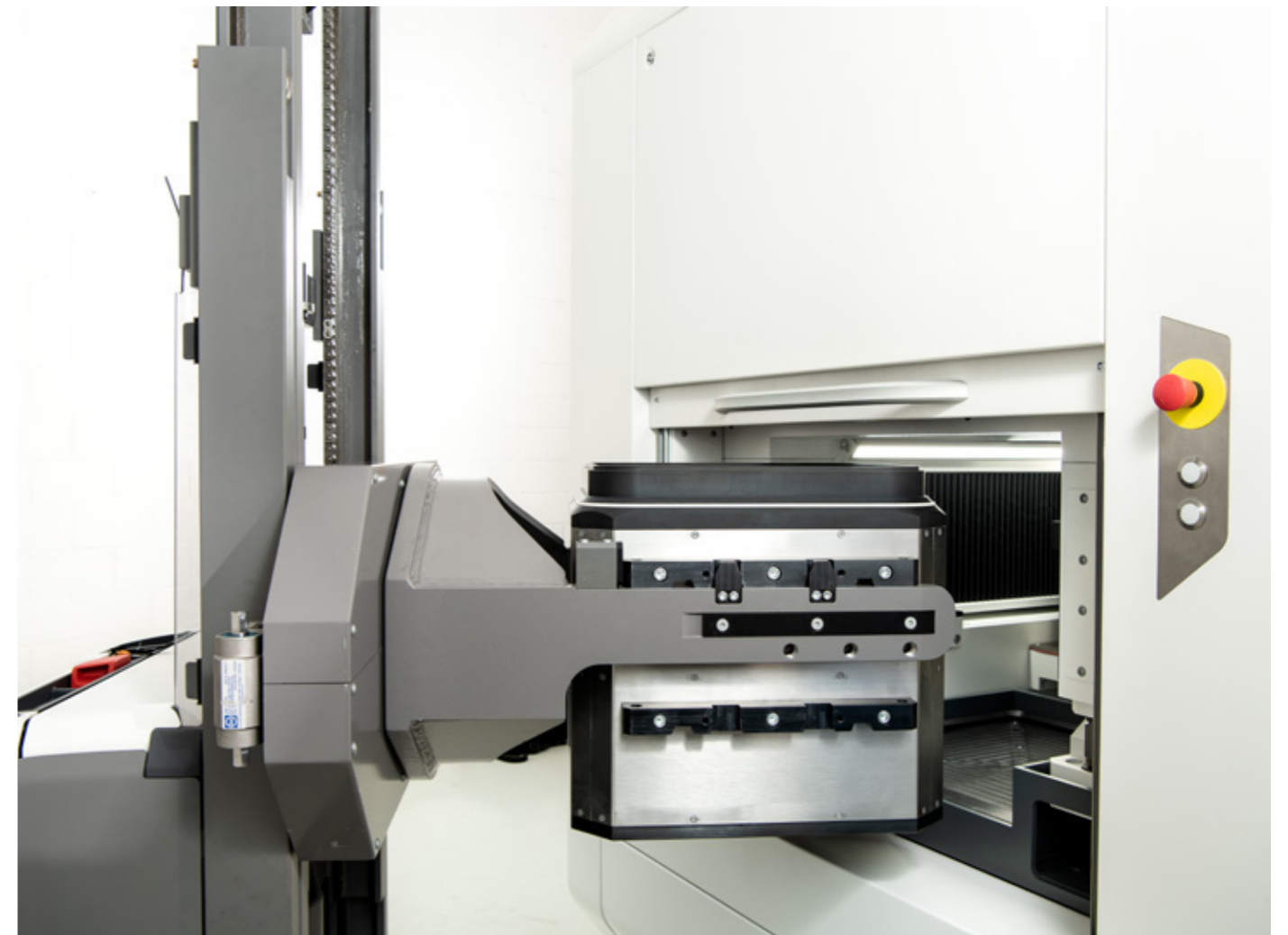



CUSTOMER CARE

WE ARE HERE FOR YOU!

Our products are designed to meet customer demands for as long as possible, they are intended to operate efficiently, reliably, and be available at any time.

From "Start up" through to "Retrofit" – our Customer Care is there for you throughout the working life of your machine. That is why over 200 competent service contacts worldwide in 10 spoken languages are available locally.

- We will provide you with fast, straight-forward support
- We will help to increase your productivity
- We work professionally, reliably and transparently
- We will provide a professional solution to your problems

UNITED GRINDING DIGITAL SOLUTIONS™

We develop solutions to support you in simplifying processes, boosting your machines' efficiency and increasing overall productivity under the "UNITED GRINDING Digital Solutions™" brand.

We are continuously expanding our solution portfolio in the key areas of CONNECTIVITY, USABILITY, MONITORING, and PRODUCTIVITY to make your work in the digital age significantly easier.

Find out more about UNITED GRINDING Digital Solutions™ services on our website in the Customer Care section.



Start up
Commissioning
Warranty extension



Qualification
Training
Production support



Prevention
Maintenance
Inspection



Service
Customer service
Customer consultation
HelpLine



Digital Solutions
Remote Service
Service Monitor
Production Monitor

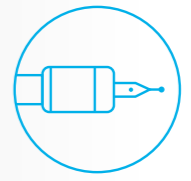

Material
Spare parts
Replacement parts
Accessories



Rebuild
Machine overhaul
Assembly overhaul



Retrofit
Modifications
Retrofits

TECHNICAL SPECIFICATIONS

MAIN DIMENSIONS

Total system length	4,100 mm
Total system width	2,300 mm
Total system height	2,300 mm

MACHINE CORE MAIN DIMENSIONS

Machine core length	2,100 mm
Machine core width	2,300 mm
Machine core height	2,300 mm

SUPPLY UNIT MAIN DIMENSIONS

Supply unit length	2,360 mm
Supply unit width	2,100 mm
Supply unit height	2,250 mm

WEIGHT

Total weight (excl. containers, powder)	9,200 kg
Machine core weight	6,700 kg
Supply unit weight	2,500 kg

MACHINE BASES/FLOOR LOAD

Machine core layout, machine bases	1,340 × 1,695 mm
Machine core point load, machine base	4× approx. 1,780 kg
Supply unit layout, machine bases	1,370 × 1,738 mm
Supply unit point load, machine base	4× approx. 625 kg

SPACE REQUIREMENTS & ASSIGNMENT PLAN

Machine space requirements (dimensions)	4,100 × 2,300 mm
Machine space requirements (area)	9.4 m ²
Front clearance	min. 1,000 mm
Rear clearance	min. 2,500 mm
Right clearance	min. 900 mm
Left clearance	min. 750 mm

BUILD VOLUME

Build space volume	450 × 300 × 400 mm ³
Substrate plate dimensions	450 × 300 × 35 mm
Effective build height	400 mm
Build container weight (excl. powder)	250 kg
Build plate heating temperature	200 °C

POWDER SUPPLY

Powder supply volume	450 × 450 × 415 mm ³
Powder overflow volume (in build container)	450 × 135 × 465 mm ³
Powder supply container weight (excl. powder)	190 kg

OPTICAL BENCH

Laser deflection unit	2× or 4× 3D scanners
Scan range	Full-field illumination
Laser	2× or 4× single-mode fiber lasers @1,070 nm
Laser power	2× 1,000 W or 4× 1,000 W
Laser beam diameter 1/e ²	90–250 μm
Maximum jump speed	20 m/s

COATER

Applicable coater types	O-ring, brush, blade, lip
Turret coater	Up to 6 positions

CONTROLLER

PLC	Beckhoff TwinCAT 3.1
Software	UGG C.O.R.E.

CONNECTED LOADS

Inert gas	
Pressure range	5.5–7 bar
Types	Nitrogen or argon
Quality	4.6

Current	
Voltage:	3× 400 VAC ± 10 %
Mains frequency	50 Hz ± 1 %
Fuse protection	63 A

Cooling water	
Cooling capacity	20 kW
Supply temperature	20°C (± 5 K)
Minimum cooling water volume flow	35 l/min

Network	
Connection	Gigabit Ethernet TCP/IP via RJ45

Compressed air	not necessary
-----------------------	---------------

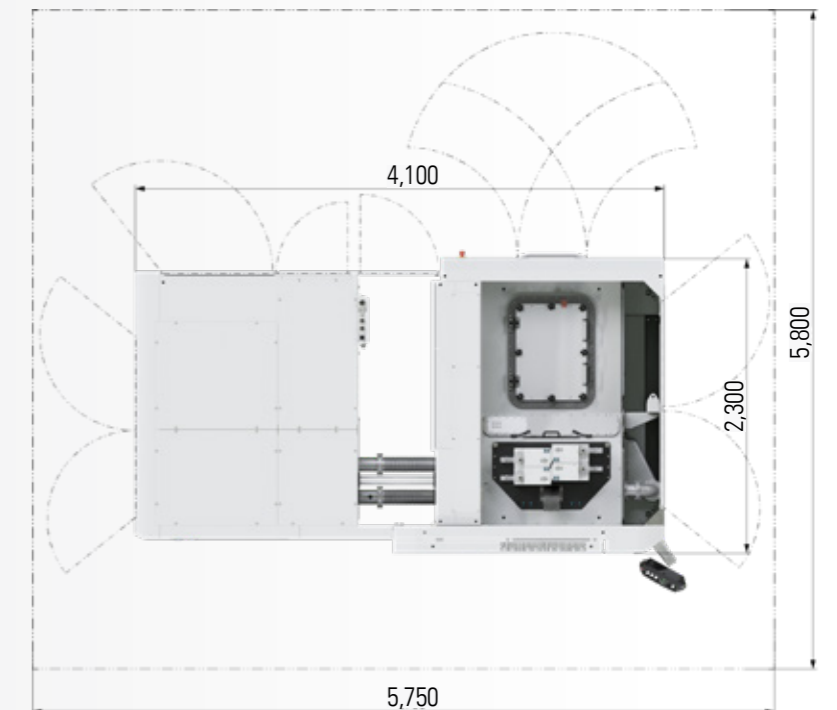
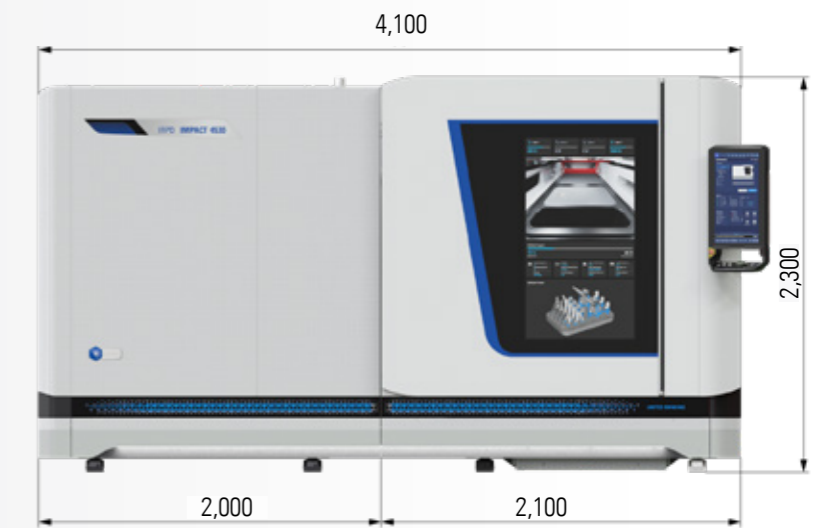

The information given is based on the technical levels of our machine at the time of this brochure going to print. We reserve the right to further develop our machines technically and make design modifications. This means that the dimensions, weights, colours, etc. of the machines supplied can differ. The diverse application possibilities of our machines depend on the technical equipment specifically requested by our customers. The equipment specifically agreed with the customer is therefore exclusively definitive for the equipping of the machines, and not any general data, information or illustrations.

IRPD

IRPD, based in St. Gallen, has been an innovator in additive manufacturing since 1996. We are market and technology leaders in Switzerland in the areas of technology transfer, design, production, and distribution.

Since 2015, IRPD has been the Center of Excellence in Additive Manufacturing within the UNITED GRINDING Group.

Our services range from topology optimization and re-design of components for additive manufacturing, material development, process parameter qualification of materials, to manufacturing and qualification of components.

Our customers are market leaders in the machine tool, aerospace, tool manufacturing and automation, energy, automotive, and medical industries.

In the job shop in St. Gallen, LPBF (Laser Powder Bed Fusion) manufacturing cells developed at IRPD and built by the UNITED GRINDING Group are in daily use. We supply our customers worldwide with the required post-processing or component refinement, from single batch to efficient series production. IRPD achieves 100% TQM according to customer requirements on a single component within the build job.

In our ThinkAdditive® workshops we create an active knowledge transfer for our customers. The modules are thematically tailored to R&D, production, customer service, and management.



UNITED GRINDING GROUP

The UNITED GRINDING Group is one of the world's leading manufacturers of precision machines for grinding, eroding, laser, measuring, and combination machining. With around 2500 employees at more than 20 manufacturing, service, and sales locations, the Group has a customer-oriented and effective organization.

With its company brands MÄGERLE, BLOHM, JUNG, STUDER, SCHAUDT, MIKROSA, WALTER, and EWAG as well as competence centers in the US and Asia, UNITED GRINDING offers a broad application knowledge, an extensive product portfolio and a complete array of services for surface and profile grinding, cylindrical grinding and tool machining. In addition, a competence center for additive manufacturing is operated under the IRPD brand.

“We want to make our customers even more successful.”

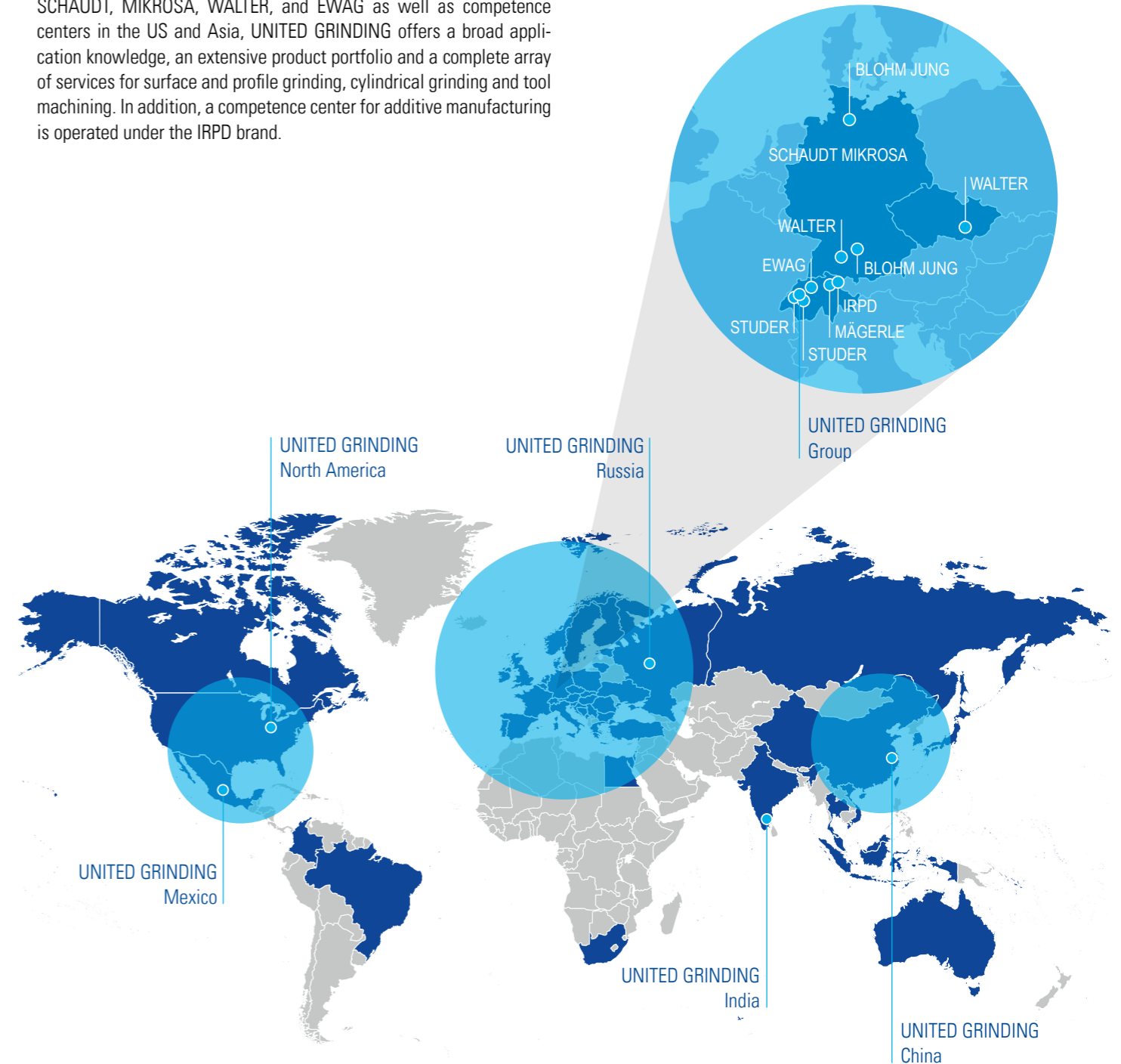



Irpd AG
9014 St. Gallen
Switzerland
Phone +41 71 274 73 10
info@irpd.ch
irpd.ch

